

ECONOMICAL 4-DIGIT DUAL-DISPLAY PID TEMPERATURE CONTROLLER



TX4 Series

INSTRUCTION MANUAL

TX4 230808EN

Thank you for choosing our product.

Please read and understand the instruction manual before using it.

For your safety, read and follow the below Safety considerations before using.

For your safety, read and follow the considerations in the instruction manual, other manuals and the website.

Keep this instruction manual in a place where you can find it easily.

The product specifications, dimensions, etc., are subject to change due to improvement or discontinuation without notice.

Follow the website for the latest information.

Safety Considerations

- Observe all 'Safety Considerations' for safe and proper operation to avoid hazards.
- ⚠ Accidents or dangers may occur under particular conditions.

⚠ Warnings Failure to follow instructions may result in severe injury or death

01. Fail-safe device must be installed when using the unit with machinery that may cause severe injury or substantial economic loss.(e.g. nuclear power control, medical equipment, ships, vehicles, railways, aircraft, combustion apparatus, safety equipment, crime/disaster prevention devices, etc.)

Failure to follow may result in personal injury, economic loss or fire.

02. Do not use the unit in flammable/explosive/corrosive gas, high humidity, direct sunlight, radiant heat, vibration, impact or salinity environments.

Failure to follow may result in an explosion or fire.

03. Install on a device panel to use.

Failure to follow may result in fire or electric shock.

04. Do not connect, repair, or inspect the unit while the power is on.

Failure to follow may result in fire or electric shock.

05. Check 'Connections' before wiring.

Failure to follow may result in fire.

06. Do not disassemble or modify the unit.

Failure to follow may result in fire or electric shock.

⚠ Caution Failure to follow instructions may result in injury or product damage

01. When connecting the power input and relay output, use AWG 20 cable, and tighten the terminal screw with a tightening torque of 0.74 to 0.90 N m.

When connecting the sensor input and communication cable without dedicated cable, use AWG 28 to 16 cable and tighten the terminal screw with a tightening torque of 0.74 to 0.90 N m.

Failure to follow this instruction may result in fire or malfunction due to contact failure.

02. Use the unit within the rated specifications.

Failure to follow this instruction may result in fire or product damage.

03. Use a dry cloth to clean the unit, and do not use water or organic solvent.

Failure to follow this instruction may result in fire or electric shock.

04. Keep the product away from metal chips, dust, and wire residue, which flow into the unit.

Failure to follow this instruction may result in fire or product damage.

Cautions during Use

- Follow in 'Cautions during Use'. Otherwise, it may cause unexpected accidents.
- Check the polarity of the terminals before wiring the temperature sensor.
For the RTD, wire it as 3-wire type, using cables in same thickness and length.
For the thermocouple(TC), use the designated compensation wire for extending wire
- Keep away from high voltage lines or power lines to prevent inductive noise.
If installing the power line and input signal line closely, use a line filter or varistor at the power line and a shielded wire at the input signal line.
Do not use equipment which generates strong magnetic force or high-frequency noise.
- Install a power switch or circuit breaker in an easily accessible place for ON or OFF the power.
- After changing the input sensor, modify the value of the corresponding parameter.
- Make a required space around the unit for the radiation of heat.
- For accurate measurement, warm up over 20 min after turning on the power.
- Do not connect unused terminals.
- This unit can be used in the following environments.
 - Indoors (in the environment condition rated in 'Specifications')
 - Altitude Max.2,000 m
 - Pollution degree 2
 - Installation category II

Display character meanings

0	1	2	3	4	5	6	7	8	9
A	b	c	d	E	F	G	H	i	J
K	L	M	n	o	P	q	r	S	t
U	v	W	X	y	Z	-			

Ordering Information

For reference only, the actual product does not support all combinations.

T X 4 - ① ② ③ ④ - ⑤

① Size

S : DIN W 48 × H 48 mm
H : DIN W 48 × H 96 mm
W : DIN W 96 × H 48 mm
M : DIN W 72 × H 72 mm
L : DIN W 96 × H 96 mm

④ Input type

T/R : TC (K E J N T S R B)
RTD (Pt100 Cu50)

② Control output

W : Relay/SSR drive

⑤ Power supply

2 : 100-240VAC/DC
4 : 24VAC/DC

③ Alarm outputs

1 : Alarm 1
2 : Alarm 1 / 2

Product Components

- Product
- Instruction manual
- Bracket

Specifications

Power supply	① 100-240VAC/DC ② 24VAC/DC	
Allowable voltage range	90% - 110% of power supply	
Power consumption	≤ 8VA	
Input type	TC	K E J N T S R B
	RTD	Pt100 Cu50
Display accuracy	±0.5%	
Control output	Relay	250VAC~3A
	SSR	12VDC≐ ±2V, ≤20mA
Alarm output	Relay	AL1/2 :250VAC~3A 1NO
Control type	ON/OFF、PID	
Sampling period	100ms	
Relay life cycle	Mechanical	≥2,500,000 operations
	Electrical	≥100,000 operations
Dielectric strength	Between all terminals and case: 3,000VAC ~ 50/60Hz for 1 min	
Vibration	0.75mm amplitude at frequency 5 to 55Hz (for 1 min.) in each X, Y, and Z direction for 2 hours	
Insulation resistance	≥100MΩ (500VDC ≐ megger)	
Noise immunity	±2KV square shaped noise (pulse width 1us) by noise simulator R-phase, S-phase	
Memory retention	≈10 years(non-volatile semiconductor memory type)	
Ambient temp.	-10~50°C storage:-20 ~ 60°C (no freezing or condensation)	
Ambient humi.	35%~85%RH storage : 35%~85%RH (no freezing or condensation)	

Input Type and Using Range

The setting range of some parameters is limited when using the decimal point display.

Input type	Display	Decimal point	Using range (°C)	Using range (°F)
Thermocouple	K	1	-30 ~ 1300	-22 ~ 2372
		0.1	-30.0 ~ 999.0	-22.0 ~ 999.0
	E	1	-30 ~ 700	-22 ~ 1292
		0.1	-30.0 ~ 700.0	-22.0 ~ 999.0
	J	1	-30 ~ 900	-22 ~ 1652
		0.1	-30.0 ~ 900.0	-22.0 ~ 999.0
	N	1	-30 ~ 1000	-22 ~ 1832
		0.1	-30.0 ~ 999.0	-22.0 ~ 999.0
	T	1	-30 ~ 400	-22 ~ 752
		0.1	-30.0 ~ 400.0	-22.0 ~ 752.0
S	1	0 ~ 1760	32 ~ 3200	
	0.1	0 ~ 999.0	32.0 ~ 999.0	
	1	0 ~ 1750	32 ~ 3182	
	0.1	0 ~ 999.0	32.0 ~ 999.0	
R	1	200 ~ 1800	392 ~ 3272	
	0.1	200.0 ~ 999.0	392.0 ~ 999.0	
B	1	200.0 ~ 999.0	392.0 ~ 999.0	
	0.1	200.0 ~ 999.0	392.0 ~ 999.0	
	1	-200 ~ 650	-328 ~ 1202	
	0.1	-99.0 ~ 650.0	-99.9 ~ 999.0	
Pt100	1	-50 ~ 150	-58 ~ 302	
	0.1	-50.0 ~ 150.0	-58.0 ~ 302.0	
Cu50	1	-50 ~ 150	-58 ~ 302	
	0.1	-50.0 ~ 150.0	-58.0 ~ 302.0	

Unit Descriptions

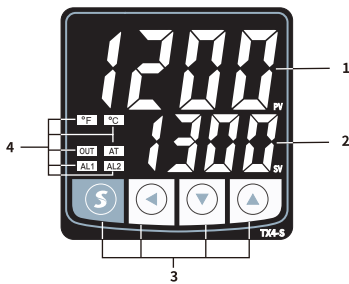

1. PV display part (Green)

- RUN mode : Displays PV (Present value)
- Setting mode : Displays parameter name

2. SV display part (Red)

- RUN mode : Displays SV (Setting value)
- Setting mode : Displays parameter setting value

3. Input key

Display	Name
[M]	Mode key
[<], [0], [>]	Setting value control key

4. Indicator

Display	Name	Description
°C, °F	Temperature unit	Displays the unit
AT	Auto tuning	Flashes during auto-tuning every 1 sec
OUT	Control output	Turns ON when the control output is ON
AL1 / 2	Alarm output	Turns ON when the alarm output is ON

5. PC loader port : For connecting the communication converter (sold separately).

Errors

Display	Description	Output	Treatment
HHHH	The PV is higher than input range	OFF	When PV is within the rated input range, this display disappears
LLLL	The PV is lower than input range	OFF	

Dimensions

- Below is based on TX4-S Series, Unit: mm

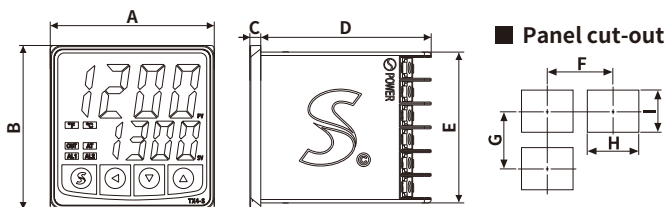

	Body			Panel cut-out					
	A	B	C	D	E	F	G	H	I
TX4-S	48	48	3	50	44.5	≥70	≥70	45	45
TX4-H	48	96	3	50	91	≥70	≥120	45	92
TX4-W	96	48	3	50	44.5	≥120	≥70	92	45
TX4-M	72	72	3	50	67	≥95	≥95	68	68
TX4-L	96	96	3	50	91	≥120	≥120	92	92

Bracket

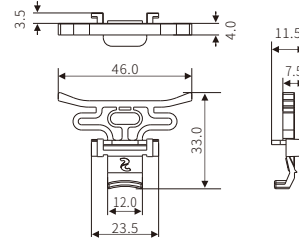

Installation Method

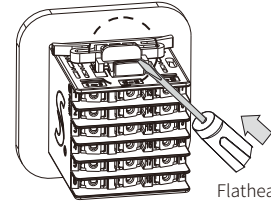

Flathead screwdriver

Insert the unit into a panel, fasten the bracket by pushing with a flathead screwdriver

Connections

TX4-S

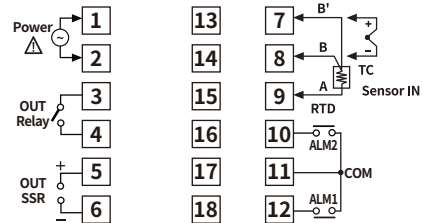

TX4-H / W / L

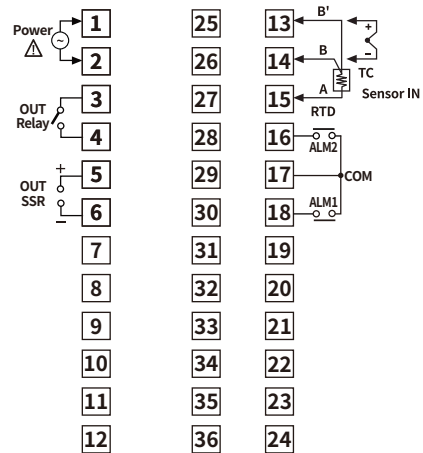

TX4-M

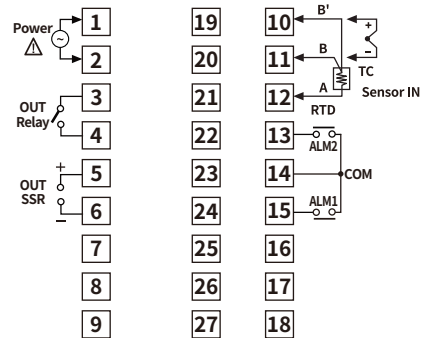

Crimp Terminal Specifications

- Unit: mm, Use the crimp terminal of follow shape

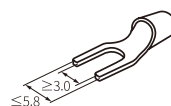

Fork crimp terminal

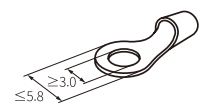

Round crimp terminal

● Integral time

Integral action automatically corrects the offset caused by proportional control to keep the SV stable.

Integral time is the unit indicating the strength of the integral operation. It is the time when the MV of the constant deviation and the MV by the proportional operation are same.

If the integral time is shortened, the correction operation becomes stronger, and the offset can be removed within a short time, but it causes vibration.

If the integral time is long, the correction operation becomes weak, and it takes a long time to eliminate the offset.

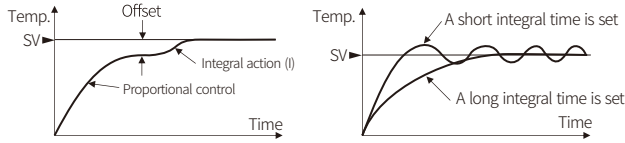

● Derivative time

The differential action adjusts the manipulated variable in proportion to the slope of the temperature change, quickly responding to sudden temperature changes due to disturbance and stabilising the control within a short time.

Derivative time is the unit for the strength of the derivative action. It is the time when the MV of differential and the MV by proportional control are same.

If the derivative time is shortened, the correction action to the disturbance temperature is weakened, and the response to the sudden temperature change is slowed, but overshoot does not occur.

If the derivative time is long, the correction action for the disturbance temperature becomes stronger, and overshoot is easy to occur.

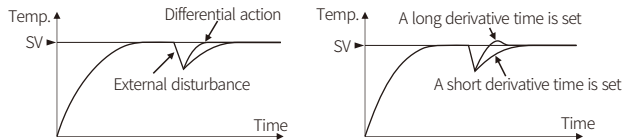

■ ON/OFF Return Value

Set the interval data between the ON and OFF of the ON/OFF control.

ON/OFF return value [αH] will show, when the Control type [Pid] is " αFF ".

If the return difference is too small, the control output may become unstable due to external interferences.

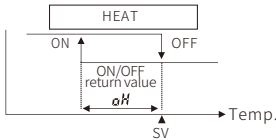

■ Input corrects

The controller itself has no error, for correct errors occurring in external inputs.

The input correct function can be mainly used when the sensor cannot be directly attached to the control object to be measured, or when the temperature difference between the location where the sensor is attached and the location to be measured is corrected.

- Example) When the actual temperature is 80°C, and the displayed temperature of the thermostat is 78°C, set Input correct [ϵL]: 002 and the display temperature is 80°C.
- $HHHH$ or $LLLL$ is displayed when the input correction result value, PV, is out of the range for each input sensor.

■ Shortcut Key

Shortcut key parameters	Display	Description
\odot 3s		Operation Auto-tuning, continue to press \odot for 3 sec. again to stop.
\odot 3s		Enter Manual mode, modify output (P00-P100) by \odot and \odot keys, press \odot key once to exit manual mode and return to RUN mode.
\odot + \odot 3s		Control output change, rLy is Relay outputs, $55r$ is SSR outputs.

■ Parameter Reset

Hold on \odot + \odot for 3s will enter $P-4$;

After putting the password 911, enter the initialisation settings [$rE5$].

If the selection is " no ", it will return; if it is " YES ", all parameters are initialised.

- Control output [αHt] won't be initialised.

■ AL1 Alarm Operation

set value	Alarm operation	Positive alarm value (AL1)	Negative alarm value (-AL1)	Deviation alarm/ absolute value alarm
0	OFF	Not used		
1	High-limit alarm			Deviation alarm
2	Low-limit alarm			Deviation alarm
3	High/low-limit reverse alarm		Always OFF	Deviation alarm
4	High/low-limit alarm		Always ON	Deviation alarm
5	Absolute value high-limit alarm			Absolute value alarm
6	Absolute value low-limit alarm			Absolute value alarm
10	OFF	Not used		
11	Standby high-limit alarm			Deviation alarm
12	Standby low-limit alarm			Deviation alarm
13	Standby high/low-limit reverse alarm		Always OFF	Deviation alarm
14	Standby high/low-limit alarm		Always ON	Deviation alarm
15	Standby absolute value high-limit alarm			Absolute value alarm
16	Standby absolute value low-limit alarm			Absolute value alarm

■ AL2 Alarm Operation

Same as AL1 alarm type, Initial value is "0".

● Deviation Alarm

Used when you want to create a linkage with the SV. The alarm action point changes in response to the change of SV.

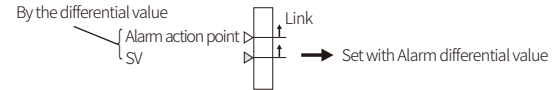

● Absolute Value Alarm

Used when no required linkage with the SV.

User temperature (absolute value)

Set alarm action points

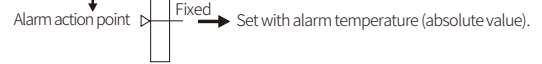

● Standby Function

The attached standby function means that when power is on, even if currently in an alarm condition, it is ignored and always OFF. When the temperature enters the non-alarm range, the attached standby mode ends.

Example) Alarm type: Standby low-limit alarm

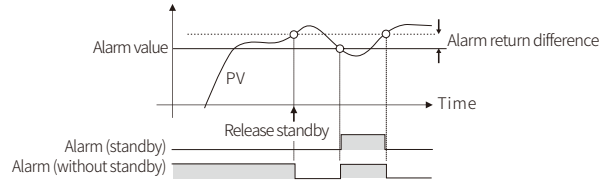

■ AL1 Alarm Return Difference

Difference needed to return to a non-alarm state.

Example) AL1 alarm temperature [Rt] is set to 120, AL1 alarm return value [RHt] is 20, the alarm is ON when the temperature reach 120°C, and the alarm is OFF when the temperature is less than 100°C.

- Range: 0 ~ 100°C
- Initial value: 0.4°C

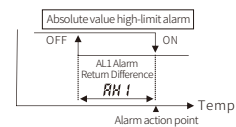

■ AL2 Alarm Return Difference

Same as AL2 Alarm Return Difference, Initial value is "0.4".